

Mercury 3 Cargo Pump

Market

The Mercury 3 is a general purpose, internal bearing, positive displacement, helical gear type cargo pump suitable for the discharge of a wide variety of liquid types and viscosity's from solvents to thick greases.

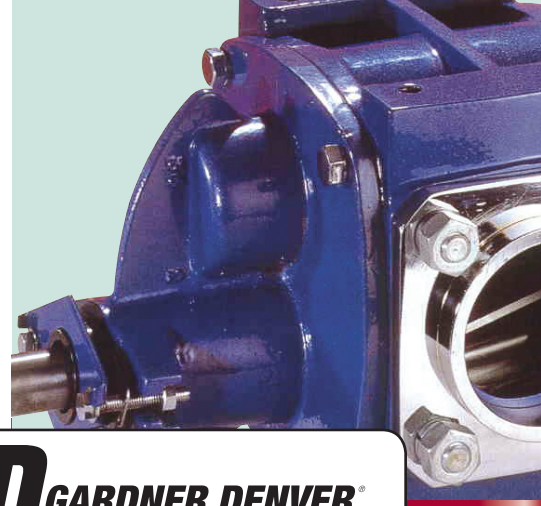
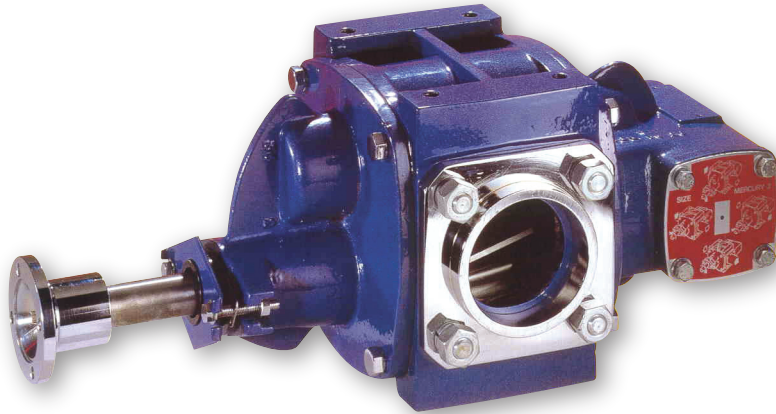

Specification

General Design

Robust assembly with twin helical gear rotors supported by bronze/carbon bush type bearing/sideplate arrangements at either end with the bearings situated in and lubricated by the liquid being pumped so that no additional lubrication / maintenance is required. The bush type bearings enable the pump to be very tolerant of difficult or low viscosity liquids.

The drive rotor meshes with and rotates the non-drive rotor (with a film of liquid sandwiched in-between).

Mounting

The pump shape and size is ideal for mounting inside the chassis on virtually all vehicles enabling low cost PTO driving where required.

The pump allows CW or ACW input drive rotation by rotating the non-drive end side plate of the pump (swapping the relief valve to the other side of the unit) and the pump can be mounted on any of its four sides to provide maximum mounting flexibility.

The Standard Package

The standard package consists of the following equipment:

1. Standard pump, packed gland seal, bronze bearings with an integral 5 or 7 bar relief valve setting. This build type is normally used with high viscosity products including Bitumen/Asphalt, Grease, Molasses and Resins.
2. Standard pump, mechanical seal, bronze bearings with an integral 5 or 7 bar relief valve setting. This build type is normally used with light to medium viscosity oil products including Diesel oil, Gas oil and Kerosene.
3. Standard pump, mechanical seal, bronze bearings with an integral pneumatic relief valve (7 bar maximum setting). This build type is normally used with light to medium viscosity oil products including Diesel oil, Gas oil, and Kerosene within larger systems requiring greater relief valve control.
4. Carbon bush version pump, packed gland seal with an integral 5 or 7 bar relief valve setting. This build type is intended for use on very thin liquids including some Solvents and Alcohols for short periods.

Helical Gear Type Cargo Pumps

■ M3

MERCURY 3 CARGO PUMP

Dimensions

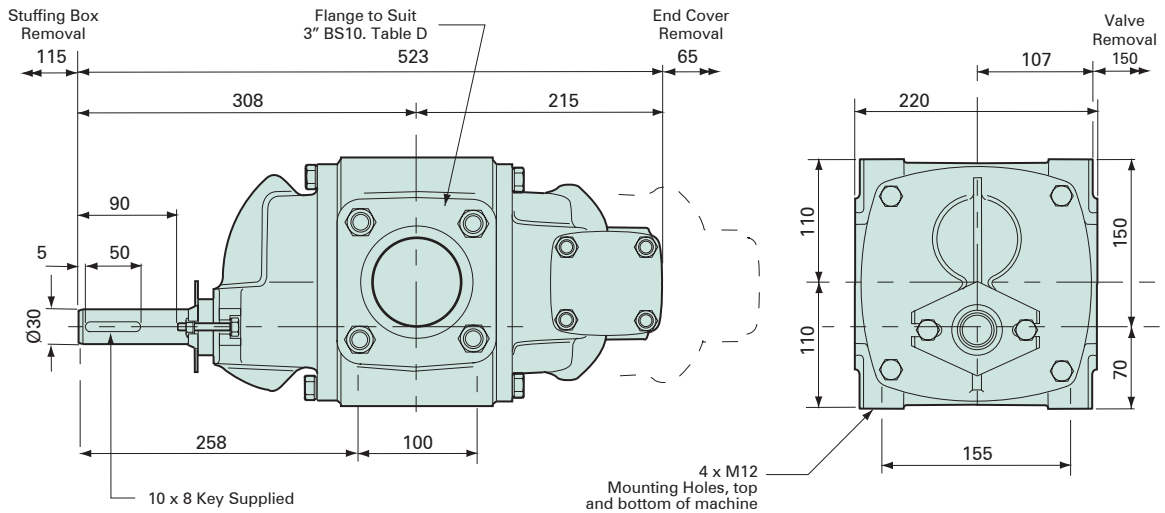

Weight Mercury 3 : 51kg

All dimensions in mm.

Optional ancillaries

- Drive flange (various)
- Inlet strainers
- Reverse flow valves

Drive options

- Prop. shaft drive:** Direct from a vehicle PTO
- Hydraulic drive:** Several drives can be offered depending on the application
- Electric motor drive:** Packages on base frames
- Engine drive:** Packages on base frames

Performance

Showing flow and power performance at a viscosity of 5 cSt

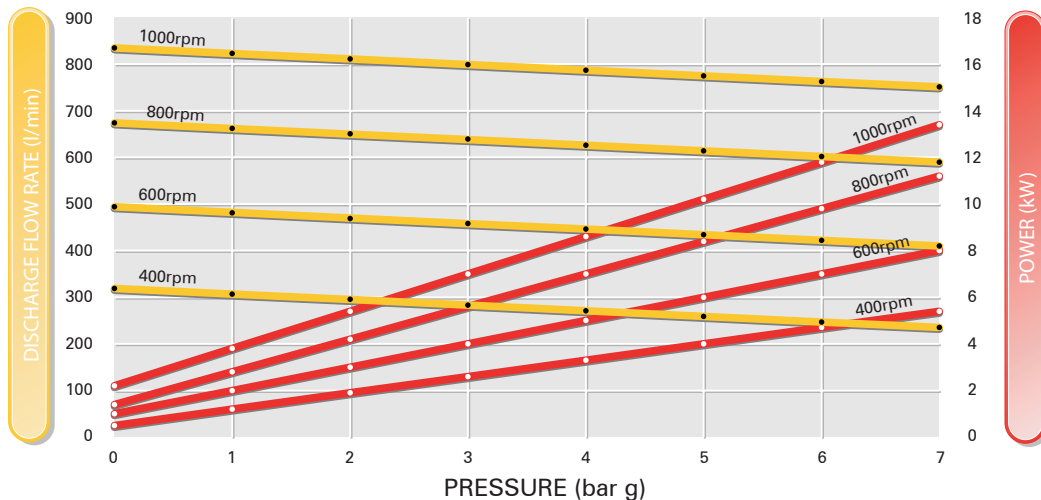

Liquid list: Generally non-toxic, non-flammable liquids with viscosity's from a few Centistokes (mm^2/s) up to many thousand including the following: Standard bronze bearings: Gas oil; Kerosene, Black oil, Lubricating Oil, Creosote, Molasses, Printing Ink, Tallow, Resins, Waste Oil, Emulsions, Silicates, Paints, Plastisizers, Grease, Bitumen/Asphalt. Carbon Bearings: Alcohol's, Aromatic solvents, Ketones, Acetates, Aliphatic Solvents, Monomers

CONTACT YOUR GARDNER DENVER REPRESENTATIVE

CONTACT HEAD OFFICE



PO Box 178, Springmill Street, Bradford, West Yorkshire, BD5 7YH, England

Tel: +44 (0) 1274 718100 Fax: +44 (0) 1274 718101

Sales: +44 (0) 1274 718160

Web: www.eu.gardnerdenver.com

e-mail: transportsales@eu.gardnerdenver.com

Copyright 2007 Gardner Denver Drum Ltd.